

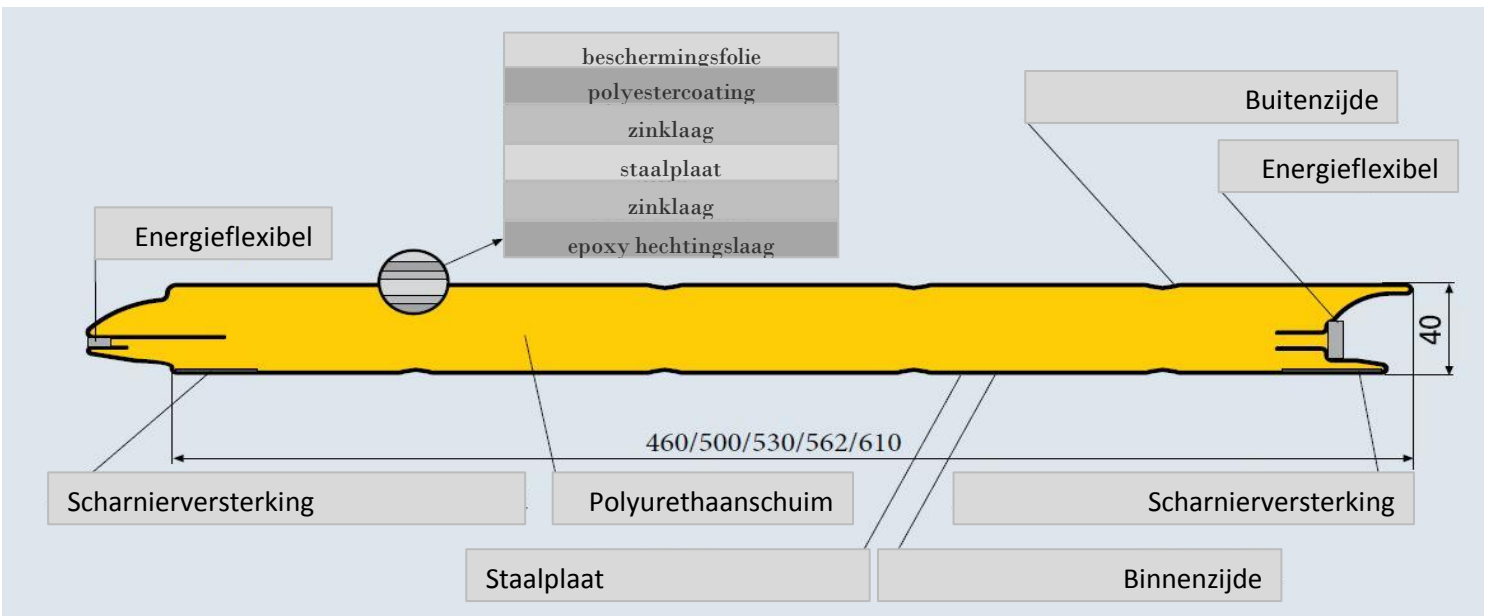

RESIDENTIEEL PANEELTYPE 001

opbouw

Sandwichpanelen voor garagepoorten.

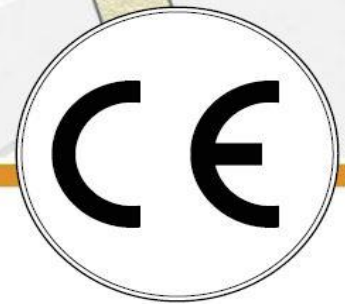



RESIDENTIEEL PANEELTYPE 001

afmetingen

SMALL

A (4:1)

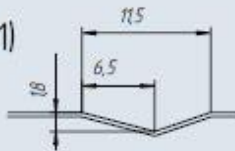

MICRO

A (4:1)

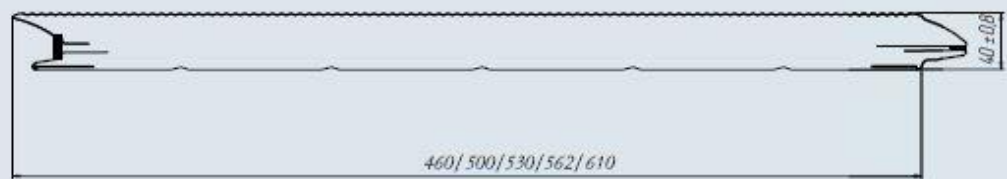
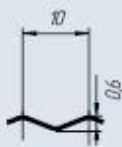

MEDIUM

A (4:1)

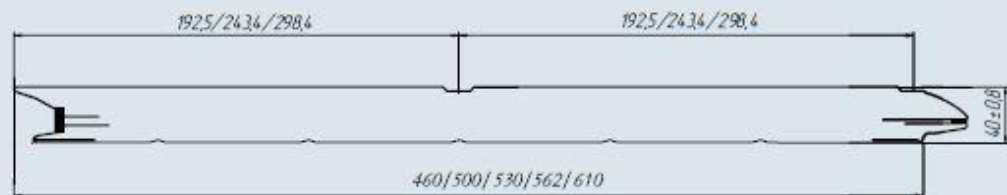
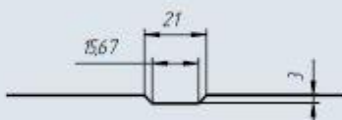



RESIDENTIEEL PANEELTYPE 001

afmetingen

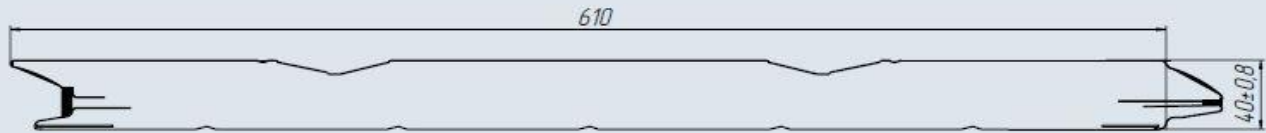

CASSET

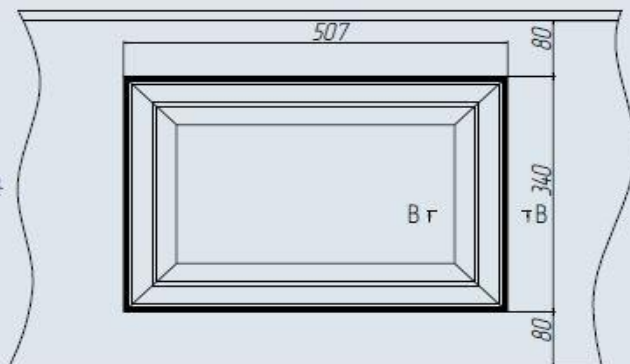
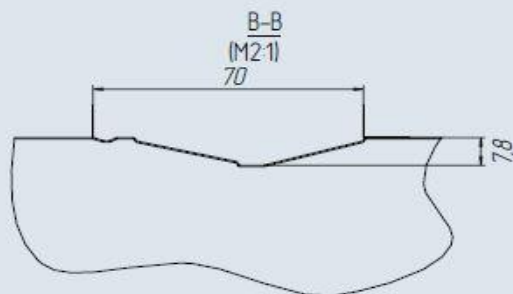
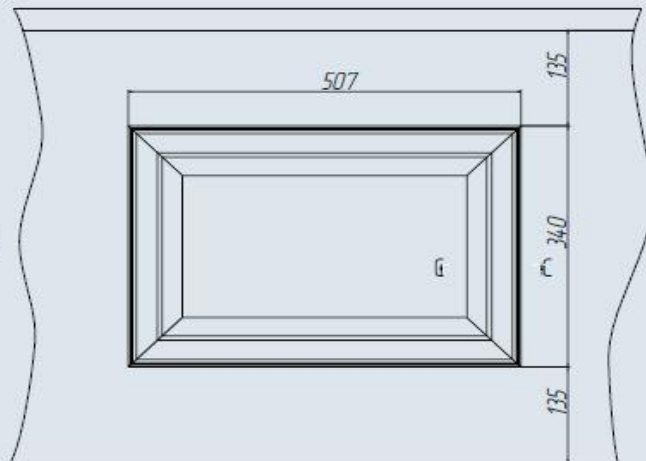
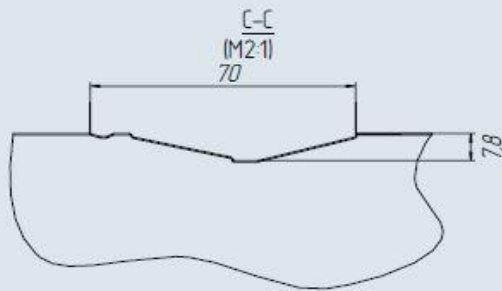



RESIDENTIEEL PANEELTYPE 001

design

PANEELDESIGN

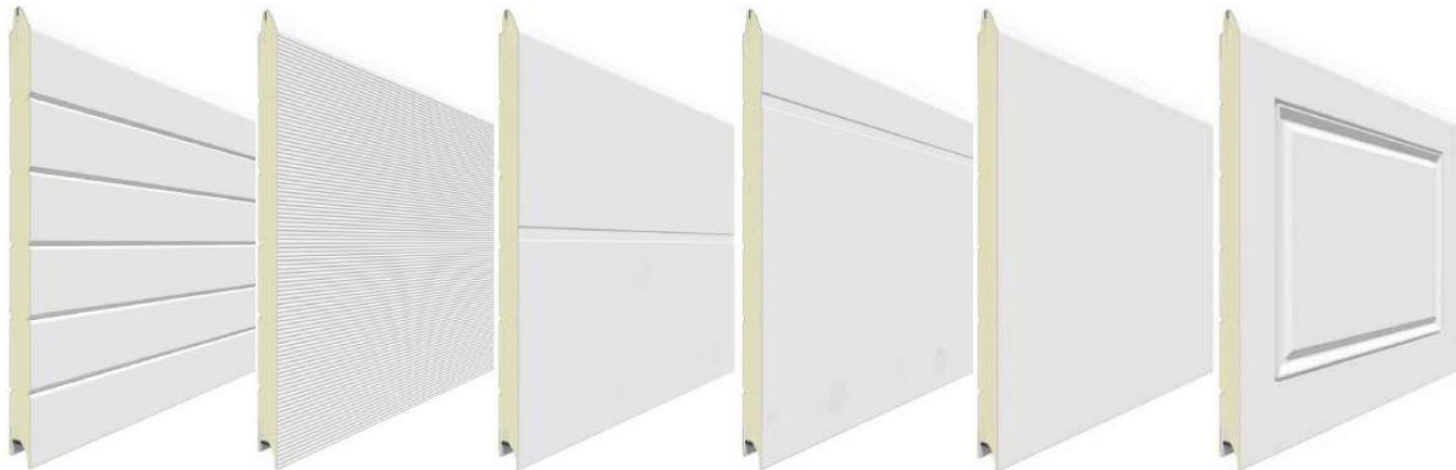

SMALL

MICRO

MEDIUM

TOP

LARGE

CASSET

OPPERVLAKTESTRUCTUUR

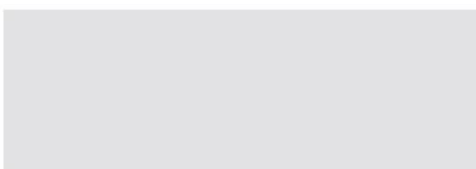

VLAK



STUCCO



HOUTNERF

PVC LAMINAAT

*Medium



DONKER EIK



GOUDEN EIK

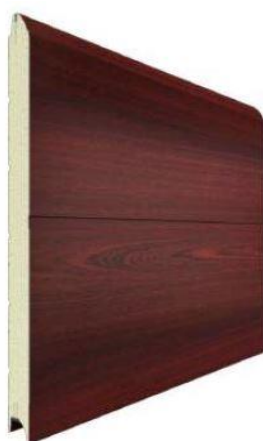

MAHONIE



WENGÉ



SATIJNGRIJS



RESIDENTIEEL PANEELTYPE 001

thermisch

THERMISCHE EIGENSCHAPPEN

GEEN KOUDE BRUG EFFECT -
de buiten- en binnenzijde zijn niet met elkaar verbonden, dit verzekert de warmte-isolatie en voorkomt bevroering

POLYURETHAANSCHUIM -
deze laag, vervaardigd uit hoogwaardig kwaliteitsmateriaal verhoogt de duurzaamheid van het sandwichpaneel en voorkomt warmteverlies.

ENERGIEFLEXIBEL

-voortuitstrevende technologie van warmte-isolatie, niet absorberend en weerbestendig materiaal.

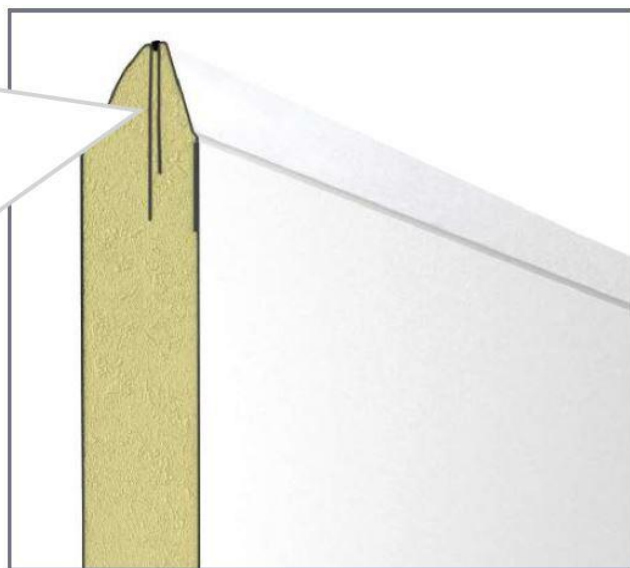
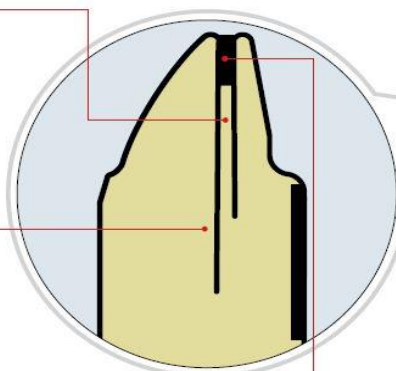

Sandwichpanelen vervaardigd uit 2 gegalvaniseerde staalplaten, gevuld met hoogwaardige thermische isolatie - geschuimd polyurethaan, hetgeen warmteverlies beperkt en de levensduur van de deur verlengt. De buiten- en binnenplaat zijn niet verbonden, om koude brug uit te sluiten, welke de warmte-isolatie verzekert en bevroering voorkomt. In de voeg wordt het polyurethaan geïsoleerd door duurzaam en waterbestendig energieflexibel.

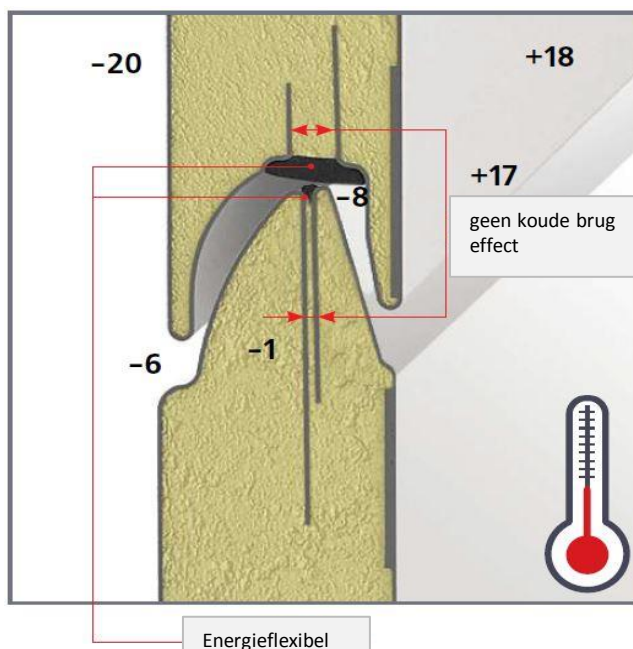

Voor veilig transport zijn de sandwichpanelen verpakt per 18 stuks met een lengte tot 13500mm. De hoeken en de zijkanten van de stapel worden bedekt met polystyreen. Het hele pakket is omwikkeld met beschermingsfolie. Elke pakket heeft zijn eigen markering.